



NAOS
THE ORIGINAL
ACTION
DESIGN

NEWS 2025

CREATIVE
INSPIRATIONS
NAOS

TABLES

FUSION	<i>pag. 5</i>
GRAVITY	<i>pag. 11</i>
SAMBA	<i>pag. 17</i>
ANT	<i>pag. 23</i>

COFFEE TABLES

AURUM RECT	<i>pag. 29</i>
AURUM ROUND	<i>pag. 35</i>
BALESTRA	<i>pag. 41</i>
BIO	<i>pag. 47</i>
COCOON OVAL	<i>pag. 53</i>
COCOON RECT	<i>pag. 59</i>
FOLÌ	<i>pag. 65</i>
LEAF	<i>pag. 71</i>
LIFTIX ROUND	<i>pag. 77</i>
LIFTIX SQUARE	<i>pag. 79</i>

FUSION

design A. Casati

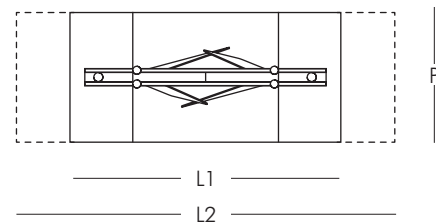
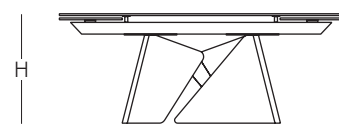

EXTENSIBLE TABLE

- | L1 | L2 | P |
|-----------|-----------|----|
| 180 → 260 | x 100/110 | cm |
| 200 → 280 | x 100/110 | cm |
| 220 → 300 | x 100/110 | cm |
- H: 75cm

FIX TABLE

- | L | P |
|-----|-----------|
| 180 | x 100/110 |
| 200 | x 100/110 |
| 240 | x 100/110 |
| 280 | x 100/110 |
- H: 75cm

TAVOLO DA PRANZO ESTENSIBILE, CON PIANO E PROLUNGHE IN CRISTALLO. BASE E BINARIO IN METALLO VERNICIATO. DOTATO DI UN AGEVOLE MECCANISMO BREVETTATO, PER ESTRARRE LE PROLUNGHE LATERALI CHE CONSENTE DI AMPLIARE IL PIANO DI CM 80. DISPONIBILE ANCHE CON PIANI IN CERAMICA.

TABLE DE REPAS EXTENSIBLE AVEC PLATEAU ET ALLONGES EN VERRE. BASE ET RAILS EN METAL LAQUE'. ÉQUIPÉE D'UN MÉCANISME BREVETÉ TRÈS SIMPLE D'UTILISATION QUI PERMET AUX ALLONGES DE SE DÉPLOYER ET DE PROLONGER LA SURFACE DE 80 CM. DISPONIBLE AUSSI AVEC PLATEAUX EN CERAMIQUE.

EXTENSIBLE DINING TABLE, WITH TOP AND EXTENSIONS IN GLASS. BASE AND TRACK IN PAINTED METAL. A VERY EASY PATENTED MECHANISM TO PULL OUT THE LATERAL EXTENSIONS ALLOWS THE WIDENING OF THE TOP OF CM 80 (31.5 INCH). AVAILABLE ALSO WITH CERAMICS TOPS.

AUSZIEHBARER ESSTISCH MIT PLATTE UND AUSZUEGEN AUS KRISTALLGLAS, GESTELL UND GLEISE AUS METALL, LACKIERT. EIN BEQUEMERN PATENTIERTER MECHANISMUS FÜR DIE SEITENAUSZUEGE ERLAUBT ES DEN TISCH UM CM 80 ZU VERGROESSERN. LIEFERBAR AUCH MIT KERAMIKPLATTEN.



FRAME & MECHANISM 58 SOFT RUSTY - TOPS QUARZITE PATAGONIA



FUSION *design A. Casati*



FRAME & MECHANISM 58 SOFT RUSTY - TOPS QUARZITE PATAGONIA

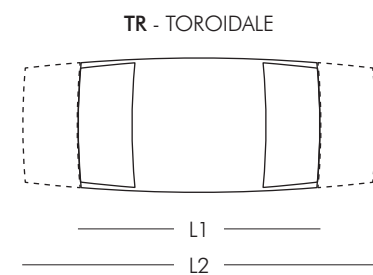
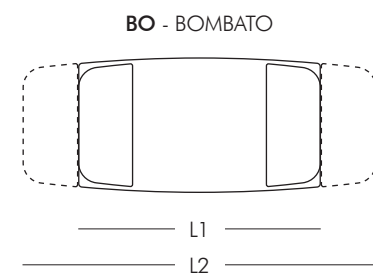
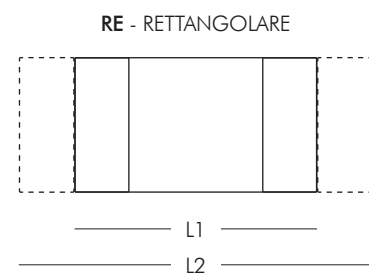

FUSION *VariActions*



FRAME & MECHANISM 88 ANODIC BRONZE - TOPS 00 NATURAL GLASS



FRAME & MECHANISM 31BR BRONZO CHAMPAGNE - TOPS CALACATTA



FRAME & MECHANISM 57 PYRITE - TOPS STATUARIO NERO

GRAVITY

design A. Casati

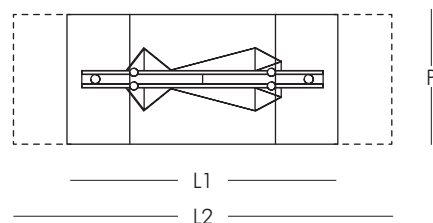
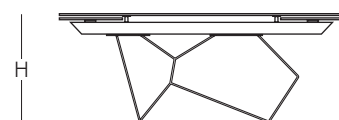

EXTENSIBLE TABLE

- | L1 | L2 | P |
|-----------|-----------|----|
| 180 → 260 | x 100/110 | cm |
| 200 → 280 | x 100/110 | cm |
| 220 → 300 | x 100/110 | cm |
- H: 75cm

FIX TABLE

- | L | P |
|-----|-----------|
| 180 | x 100/110 |
| 200 | x 100/110 |
| 240 | x 100/110 |
| 280 | x 100/110 |
- H: 75cm

TAVOLO DA PRANZO ESTENSIBILE, CON PIANO E PROLUNGHE IN CRISTALLO. BASE E BINARIO IN METALLO VERNICIATO. DOTATO DI UN AGEVOLE MECCANISMO BREVETTATO, PER ESTRARRE LE PROLUNGHE LATERALI CHE CONSENTE DI AMPLIARE IL PIANO DI CM 80. DISPONIBILE ANCHE CON PIANI IN CERAMICA.

EXTENSIBLE DINING TABLE, WITH TOP AND EXTENSIONS IN GLASS. BASE AND TRACK IN PAINTED METAL. A VERY EASY PATENTED MECHANISM TO PULL OUT THE LATERAL EXTENSIONS ALLOWS THE WIDENING OF THE TOP OF CM 80 (31.5 INCH). AVAILABLE ALSO WITH CERAMICS TOPS.

TABLE DE REPAS EXTENSIBLE AVEC PLATEAU ET ALLONGES EN VERRE. BASE ET RAILS EN METAL LAQUE'. ÉQUIPÉE D'UN MÉCANISME BREVETÉ TRÈS SIMPLE D'UTILISATION QUI PERMET AUX ALLONGES DE SE DÉPLOYER ET DE PROLONGER LA SURFACE DE 80 CM. DISPONIBLE AUSSI AVEC PLATEAUX EN CERAMIQUE.

AUSZIEHBARER ESSTISCH MIT PLATTE UND AUSZUEGEN AUS KRISTALLGLAS, GESTELL UND GLEISE AUS METALL, LACKIERT. EIN BEQUEMERN PATENTIERTER MECHANISMUS FÜR DIE SEITENAUSZUEGE ERLAUBT ES DEN TISCH UM CM 80 ZU VERGROESSERN. LIEFERBAR AUCH MIT KERAMIKPLATTEN.

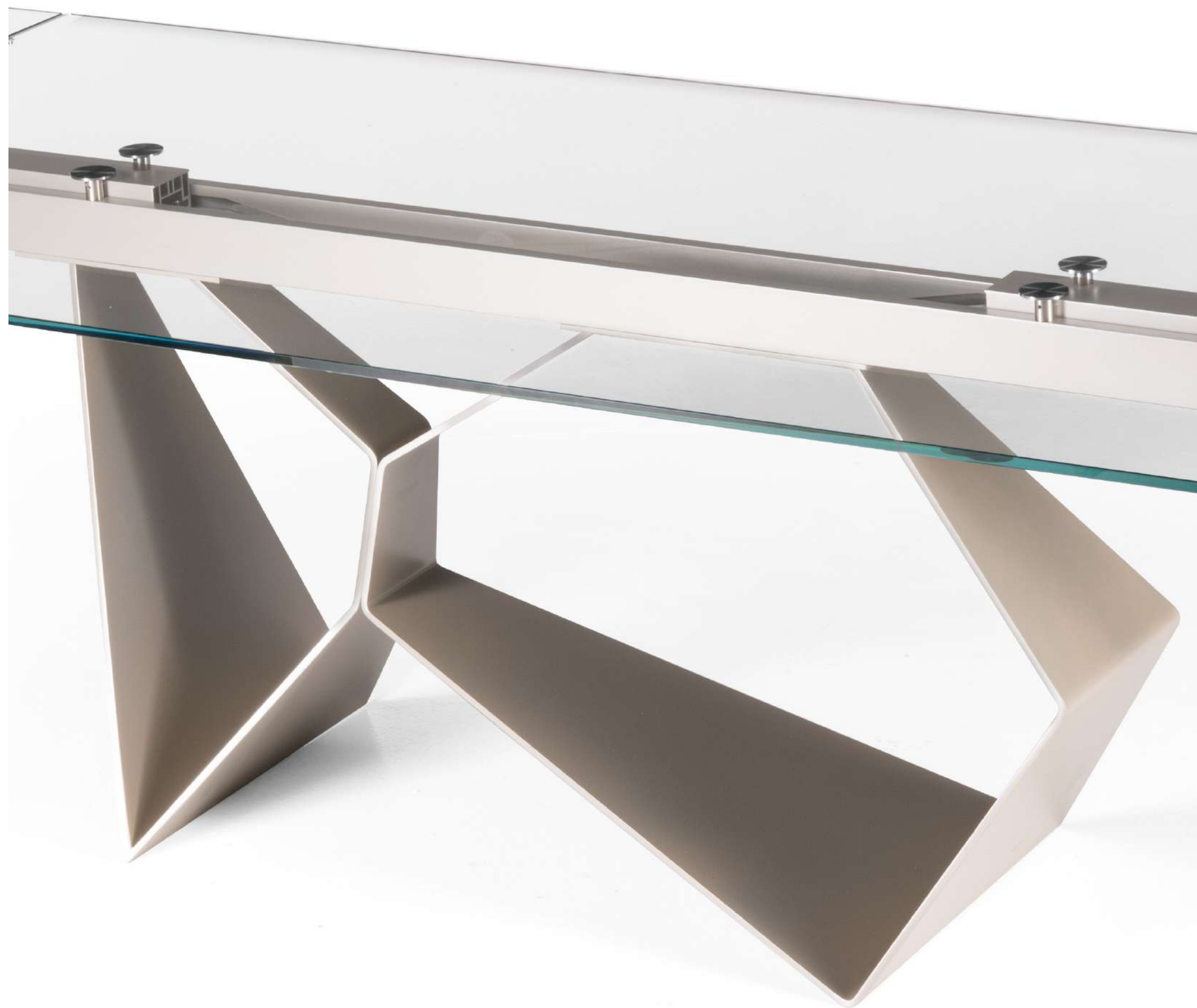

FRAME & MECHANISM 31BR BRONZE CHAMPAGNE - TOPS 00 NATURAL GLASS



GRAVITY *design A. Casati*

GRAVITY *VariActions*



FRAME & MECHANISM 54 RUSTY BROWN - TOPS 00 NATURAL GLASS



FRAME & MECHANISM 88 ANODIC BRONZE - TOPS FUSION WHITE

FRAME & MECHANISM 31 BR BRONZO CHAMPAGNE - TOPS KERAMIK WALNUT

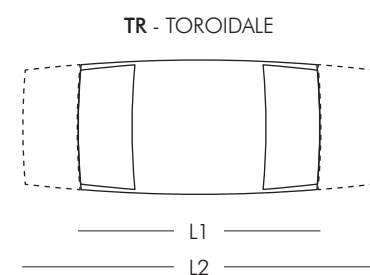
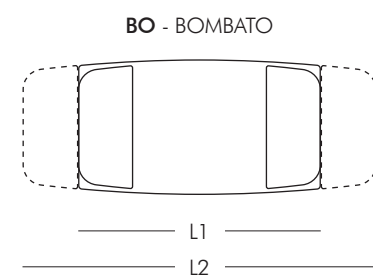
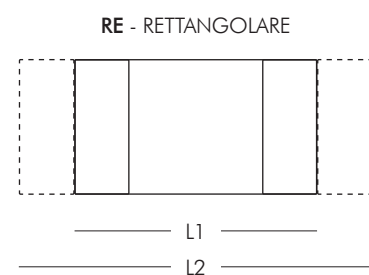

FRAME & MECHANISM 7044 SAND - TOPS OSSIDO NERO

SAMBA

design A. Tomaiuolo

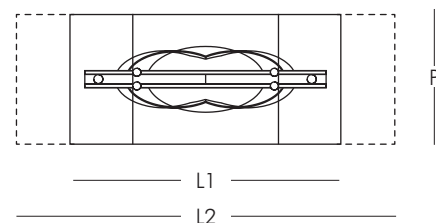
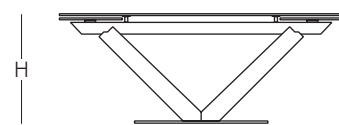

EXTENSIBLE TABLE

- | L1 | L2 | P |
|-----------|-----------|----|
| 180 → 260 | x 100/110 | cm |
| 200 → 280 | x 100/110 | cm |
| 220 → 300 | x 100/110 | cm |
- H: 75cm

FIX TABLE

- | L | P |
|---------------|----|
| 180 x 100/110 | cm |
| 200 x 100/110 | cm |
| 240 x 100/110 | cm |
| 280 x 100/110 | cm |
- H: 75cm

TAVOLO DA PRANZO ESTENSIBILE, CON PIANO E PROLUNGHE IN CRISTALLO. BASE E BINARIO IN METALLO VERNICIATO. DOTATO DI UN AGEVOLE MECCANISMO BREVETTATO, PER ESTRARRE LE PROLUNGHE LATERALI CHE CONSENTE DI AMPLIARE IL PIANO DI CM 80. DISPONIBILE ANCHE CON PIANI IN CERAMICA.

EXTENSIBLE DINING TABLE, WITH TOP AND EXTENSIONS IN GLASS. BASE AND TRACK IN PAINTED METAL. A VERY EASY PATENTED MECHANISM TO PULL OUT THE LATERAL EXTENSIONS ALLOWS THE WIDENING OF THE TOP OF CM 80 (31.5 INCH). AVAILABLE ALSO WITH CERAMICS TOPS.

TABLE DE REPAS EXTENSIBLE AVEC PATEAU ET ALLONGES EN VERRE. BASE ET RAILS EN METAL LAQUE'. ÉQUIPÉE D'UN MÉCANISME BREVETÉ TRÉS SIMPLE D'UTILISATION QUI PERMET AUX ALLONGES DE SE DÉPLOYER ET DE PROLONGER LA SURFACE DE 80 CM. DISPONIBLE AUSSI AVEC PATEAUX EN CERAMIQUE.

AUSZIEHBARER ESSTISCH MIT PLATTE UND AUSZUEGEN AUS KRISTALLGLAS, GESTELL UND GLEISE AUS METALL, LACKIERT. EIN BEQUEMENR PATENTIERTER MECHANISMUS FÜR DIE SEITENAUSZUEGE ERLAUBT ES DEN TISCH UM CM 80 ZU VERGROESSERN. LIEFERBAR AUCH MIT KERAMIKPLATTEN.



FRAME & MECHANISM 31BR BRONZO CHAMPAGNE - TOPS 00 NATURAL GLASS



SAMBA *design A. Tomaiuolo*

SAMBA *VariActions*



FRAME & MECHANISM 31BR BRONZO CHAMPAGNE - TOPS 00 NATURAL GLASS



FRAME & MECHANISM 57 PYRITE - TOPS CALACATTA



FRAME & MECHANISM 5310 TAUPE - TOPS CAPRAIA

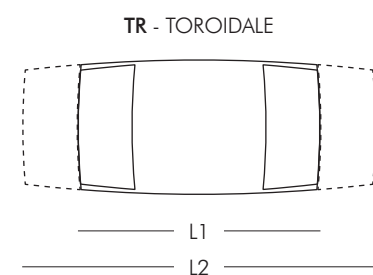
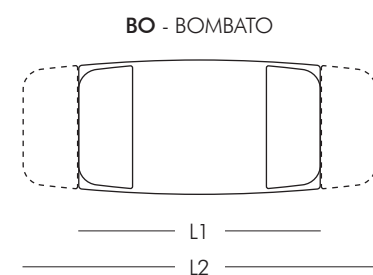
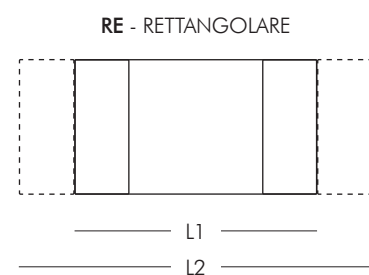

FRAME & MECHANISM 54 RUSTY BROWN - TOPS SAVOIA ANTRACITE

ANT

design A. Casati

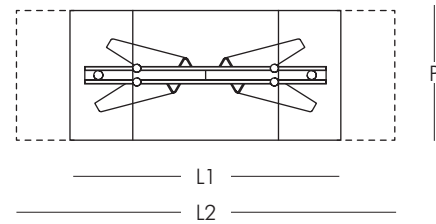
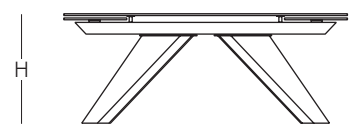

EXTENSIBLE TABLE

L1 L2 P

- 180 → 260 x 100/110 cm
 - 200 → 280 x 100/110 cm
 - 220 → 300 x 100/110 cm
- H: 75cm

FIX TABLE

L P

- 180 x 100/110 cm
 - 200 x 100/110 cm
 - 240 x 100/110 cm
 - 280 x 100/110 cm
- H: 75cm

TAVOLO DA PRANZO ESTENSIBILE, CON PIANO E PROLUNGHE IN CRISTALLO. BASE E BINARIO IN METALLO VERNICIATO. DOTATO DI UN AGEVOLE MECCANISMO BREVETTATO, PER ESTRARRE LE PROLUNGHE LATERALI CHE CONSENTE DI AMPLIARE IL PIANO DI CM 80. DISPONIBILE ANCHE CON PIANI IN CERAMICA.

EXTENSIBLE DINING TABLE, WITH TOP AND EXTENSIONS IN GLASS. BASE AND TRACK IN PAINTED METAL. A VERY EASY PATENTED MECHANISM TO PULL OUT THE LATERAL EXTENSIONS ALLOWS THE WIDENING OF THE TOP OF CM 80 (31.5 INCH). AVAILABLE ALSO WITH CERAMICS TOPS.

TABLE DE REPAS EXTENSIBLE AVEC PATEAU ET ALLONGES EN VERRE. BASE ET RAILS EN METAL LAQUE'. ÉQUIPÉE D'UN MÉCANISME BREVETÉ TRÉS SIMPLE D'UTILISATION QUI PERMET AUX ALLONGES DE SE DÉPLOYER ET DE PROLONGER LA SURFACE DE 80 CM. DISPONIBLE AUSSI AVEC PATEAUX EN CERAMIQUE.

AUSZIEHBARER ESSTISCH MIT PLATTE UND AUSZUEGEN AUS KRISTALLGLAS, GESTELL UND GLEISE AUS METALL, LACKIERT. EIN BEQUEMENR PATENTIERTER MECHANISMUS FÜR DIE SEITENAUSZUEGE ERLAUBT ES DEN TISCH UM CM 80 ZU VERGROESSERN. LIEFERBAR AUCH MIT KERAMIKPLATTEN.



FRAME & MECHANISM 88 ANODIC BRONZE - TOPS QUARZITE PATAGONIA



ANT design A. Casati

ANT VariActions



FRAME & MECHANISM 88 ANODIC BRONZE - TOPS QUARZITE PATAGONIA



FRAME & MECHANISM 44 ANTHRACITE - TOPS 00 NATURAL GLASS



FRAME & MECHANISM 5310 TAUPE - TOPS FOKOS SALE



FRAME & MECHANISM 7044 SAND - TOPS BLACK DESIRE

RE - RETTANGOLARE

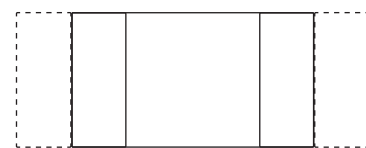

BO - BOMBATO

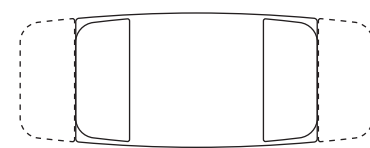

TR - TOROIDALE

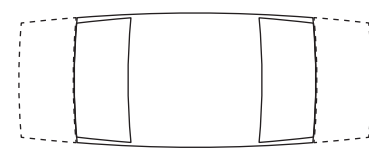

AURUM RECT

design Casati

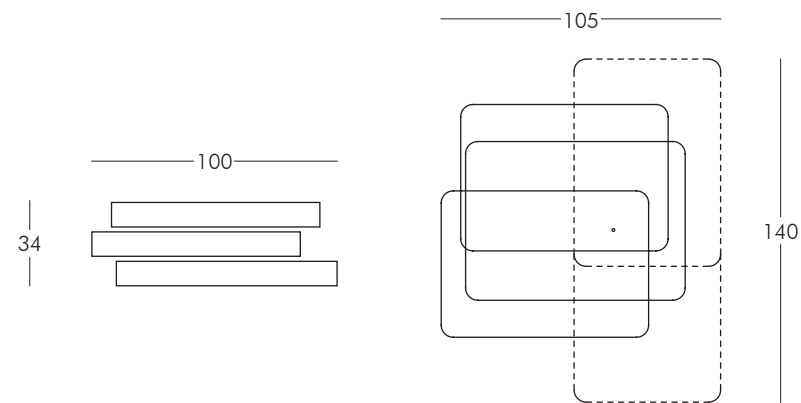

TAVOLINO ESTENSIBILE IN FORMA QUADRATA O ROTONDA CON PIANI IN CERAMICA. STRUTTURA DISPONIBILE NELLE FINITURE VERNICIATE. DOTATO DI MECCANISMO PER L'APERTURA SINCRONIZZATA DEI DUE PIANI.

EXTENSIBLE SQUARE OR ROUND COCKTAIL TABLE WITH CERAMIC TOPS. FRAME AVAILABLE IN PAINTED FINISHES. EQUIPPED WITH A MECHANISM FOR THE SYNCHRONIZED OPENING OF THE 2 TOPS.

TABLE DE SALON CARRÉE OU RONDE AVEC PLATEAUX DISPONIBLES DANS TOUTES LES FINITIONS CÉRAMIQUE. STRUCTURE DISPONIBLES EN FINITION LAQUÉE, EQUIPÉE D'UN MÉCANISME POUR L'OUVERTURE SYNCRONISÉE DES 2 PLATEAUX.

AUSZIEHBARER QUADRATISCHER ODER RUNDE COUCHTISCH MIT KERAMIK PLATTEN. GESTELL IN LACKIERTEN AUSFUHRUNGEN. AUSGESTATTET MIT EINEM MECHANISMUS FÜR DIE SYNCHRONISIERTE ERÖFFNUNG DER 2 PLATTEN.



FRAME 11 MATTE BLACK - TOPS STATUARIO NERO

AURUM RECT

VariActions

Closed

Opened



FRAME 7044 SAND - TOPS STATUARIETTO



FRAME 54 RUSTY BROWN - TOPS CAPRAIA



FRAME 7024 GRAPHITE - TOPS SAHARA NOIR

Action

AURUM ROUND

design Casati

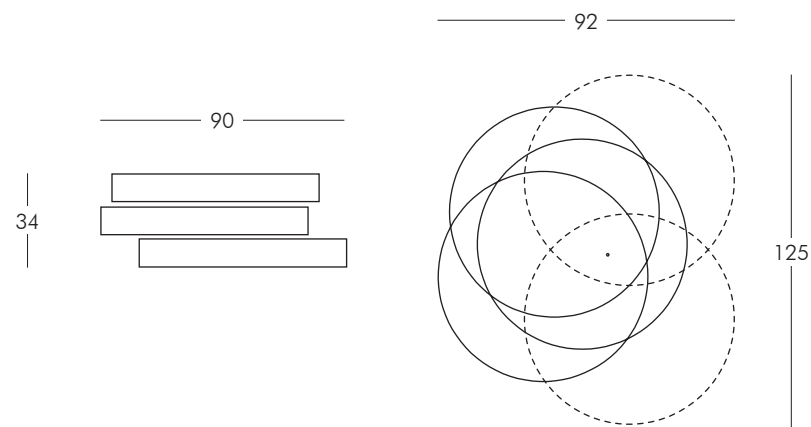

TAVOLINO ESTENSIBILE IN FORMA QUADRATA O ROTONDA CON PIANI IN CERAMICA. STRUTTURA DISPONIBILE NELLE FINITURE VERNICIATE. DOTATO DI MECCANISMO PER L'APERTURA SINCRONIZZATA DEI DUE PIANI.

EXTENSIBLE SQUARE OR ROUND COCKTAIL TABLE WITH CERAMIC TOPS. FRAME AVAILABLE IN PAINTED FINISHES. EQUIPPED WITH A MECHANISM FOR THE SYNCHRONIZED OPENING OF THE 2 TOPS.

TABLE DE SALON CARRÉE OU RONDE AVEC PLATEAUX DISPONIBLES DANS TOUTES LES FINITIONS CÉRAMIQUE. STRUCTURE DISPONIBLES EN FINITION LAQUÉE, EQUIPÉE D'UN MÉCANISME POUR L'OUVERTURE SYNCHRONISÉE DES 2 PLATEAUX.

AUSZIEHBARER QUADRATISCHER ODER RUNDE COUCHTISCH MIT KERAMIK PLATTEN. GESTELL IN LACKIERTEN AUSFUHRUNGEN. AUSGESTATTET MIT EINEM MECHANISMUS FÜR DIE SYNCHRONISIERTE ERÖFFNUNG DER 2 PLATTEN.

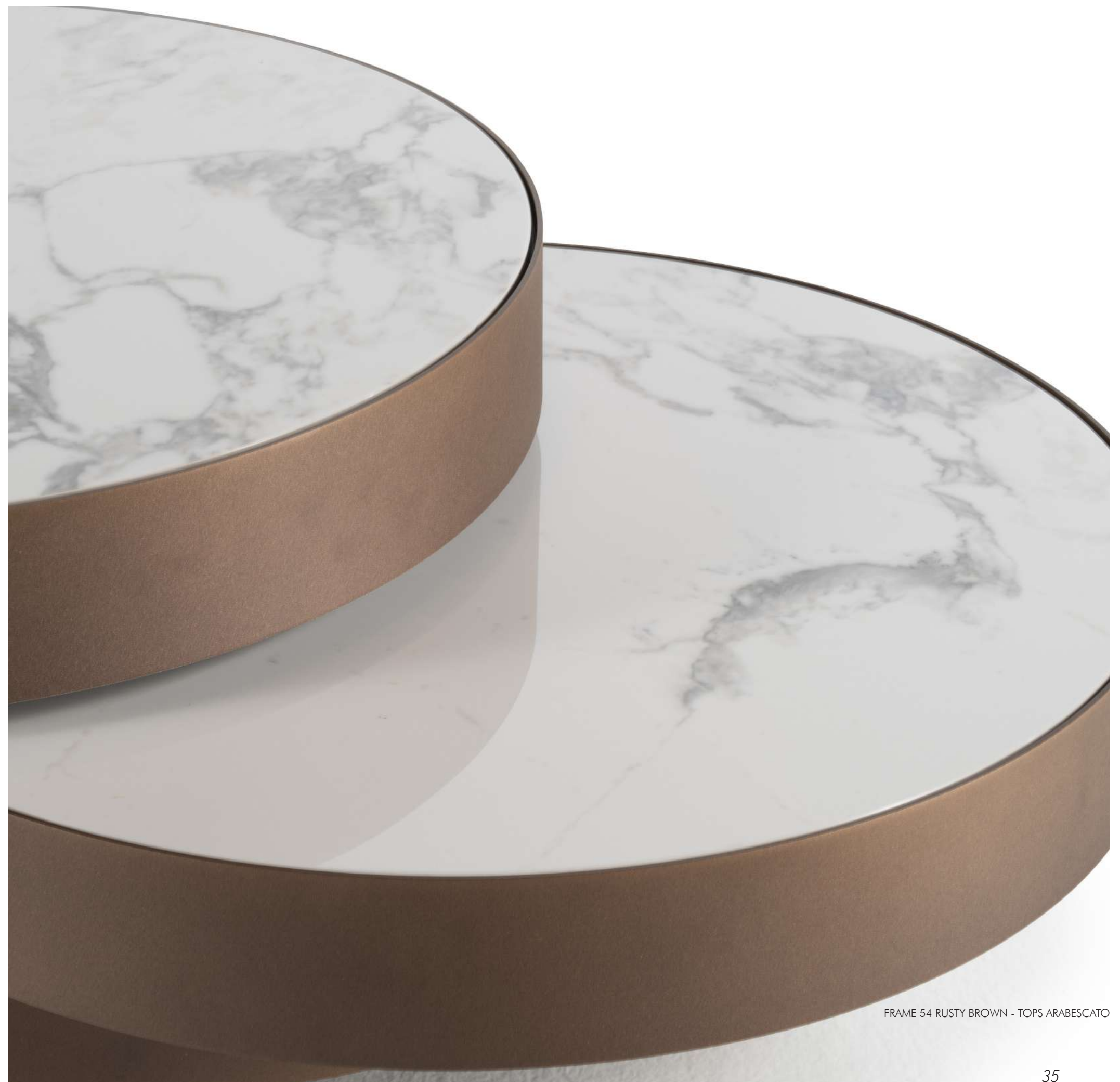

FRAME 54 RUSTY BROWN - TOPS ARABESCATO



AURUM ROUND

VariActions

Closed

Opened



FRAME 31 BR BRONZE CHAMPAGNE - TOPS INVISIBLE WHITE



FRAME 11 MATTE BLACK - TOPS SAHARA NOIR



FRAME 5310 TAUPE - TOPS PIETRA GREY

Action

BALESTRA

design Casati

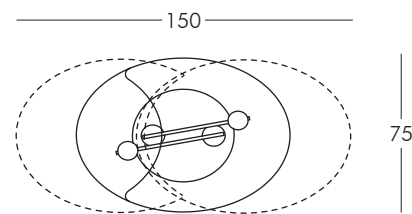
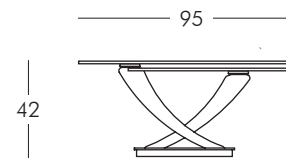

TAVOLINO ESTENSIBILE CON PIANI GIREVOLI SINCRONIZZATI DISPONIBILI IN VETRO O CERAMICA. BASE VERNICIATA E SUPPORTI IN FINITURE VERNICIATE O CON TRATTAMENTO GALVANICO. IL TAVOLINO È DOTATO DI UN MECCANISMO DI ROTAZIONE SINCRONIZZATO, CHE CONSENTE UN'AMPIA MODULAZIONE DELLA FORMA.

TABLE DE SALON AVEC PLATEAUX TOURNANTS SYNCHRONISÉES DISPONIBLES DANS TOUTES LES FINITIONS CÉRAMIQUE OU EN VERRE. BASE EN ACIER LAQUÉ ET SUPPORTS EN ACIER LAQUÉ OU GALVANISÉ. LA BASE EST EQUIPÉE D'UN MÉCANISME DE ROTATION SYNCHRONISÉE QUI PERMET UNE GRANDE VARIÉTÉ DE POSITIONS.

EXTENSIBLE COCKTAIL TABLE WITH SYNCHRONIZED REVOLVING TOPS IN GLASS OR CERAMIC SELECTIONS. PAINTED BASE AND SUPPORTS IN PAINTED FINISHES OR WITH GALVANIC TREATMENT. THE BASE IS EQUIPPED WITH A MECHANISM FOR THE SYNCHRONIZED ROTATION OF THE TOPS THAT ALLOW AMPLE MODULATION OF THE SHAPE.

AUSZIEHBARER COUCHTISCH MIT KERAMIKPLATTEN UND KRISTALLGLAS. LACKIERTEM BASIS UND TRÄGER AUS LACKIERTEM ODER GALVANISIERTEM STAHL. DER BESONDERE MECHANISMUS ERLAUBT ES DEN PLATTEN VIELFALTIGE POSITIONEN EINZUNEHMEN.



BASE 21 EMBOSSED BLACK - SUPPORTS 570 SMOKE - TOPS BLACK DESIRE / 00 NATURAL GLASS



BALESTRA

Closed



Action

VariActions

Opened



BASE 7024 GRAPHITE - SUPPORTS 37 CHROME - TOPS SAVOIA GRIGIO / 08 EXTRALIGHT GLASS



BASE 11 MATTE BLACK - SUPPORTS 33 BLACK NICKEL - TOPS SAHARA NOIR / 08 EXTRALIGHT GLASS



BASE 5270 DARK BROWN - SUPPORTS 670 COPPER - TOPS QUARZITE PATAGONIA / 00 NATURAL GLASS

BIO

design Casati

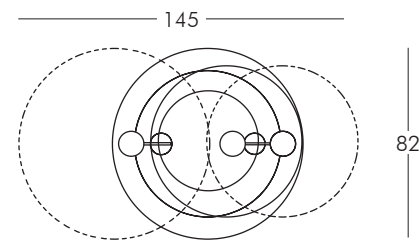
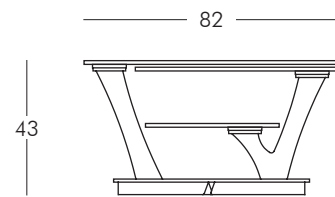

TAVOLINO ESTENSIBILE CON PIANI GIREVOLI SINCRONIZZATI DISPONIBILI IN VETRO O CERAMICA. BASE E SUPPORTI IN FINITURE VERNICIATE. IL TAVOLINO È DOTATO DI UN MECCANISMO DI ROTAZIONE SINCRONIZZATO, CHE CONSENTE UN'AMPIA MODULAZIONE DELLA FORMA.

TABLE DE SALON AVEC PLATEAUX TOURNANTS SYNCHRONISÉES DISPONIBLES DANS TOUTES LES FINITIONS CÉRAMIQUE OU EN VERRE. BASE ET SUPPORTS EN ACIER LAQUÉ. LA BASE EST ÉQUIPÉE D'UN MÉCANISME DE ROTATION SYNCHRONISÉE QUI PERMET UNE GRANDE VARIÉTÉ DE POSITIONS.

EXTENSIBLE COCKTAIL TABLE WITH SYNCHRONIZED REVOLVING TOPS IN GLASS OR CERAMIC SELECTIONS. BASE AND SUPPORTS IN PAINTED FINISHES. THE BASE IS EQUIPPED WITH A MECHANISM FOR THE SYNCHRONIZED ROTATION OF THE TOPS THAT ALLOW AMPLE MODULATION OF THE SHAPE.

AUSZIEHBARER COUCHTISCH MIT KERAMIKPLATTEN UND KRISTALLGLAS. BASIS UND TRAGER AUS LACKIERTEM STAHL. DER BESONDERE MECHANISMUS ERLAUBT ES DEN PLATTEN VIELFALTIGE POSIZIEN EINZUNEHMEN.



BASE e SUPPORTS 57 PYRITE - TOPS SAVOIA GRIGIO / 74 FUMÈ GLASS



Closed



Opened



BASE e SUPPORTS 88 ANODIC BRONZE - TOPS CALACATTA / 08 EXTRALIGHT GLASS



BASE e SUPPORTS 7044 SAND - TOPS FUSION WHITE / 08 EXTRALIGHT GLASS



BASE e SUPPORTS 56 BLACK PEARL - TOPS STATUARIO NERO / 74 FUMÈ GLASS

Action

COCOON OVAL

design D'Urbino

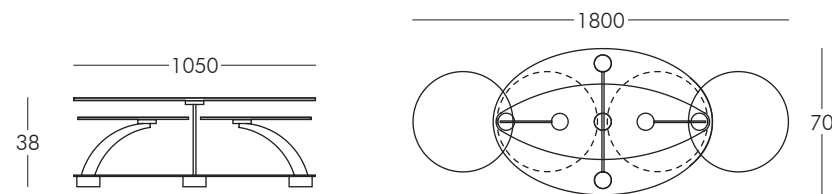

TAVOLINO ESTENSIBILE CON 3 PIANI IN CRISTALLO O CERAMICA. DOTATO DI UN INNOVATIVO DOPPIO MECCANISMO SINCRONIZZATO DI APERTURA CHE PERMETTE AI 3 CRISTALLI DI APRIRSI CON UN SOLO GESTO MA IN DIREZIONI OPPOSITE. STRUTTURA IN ACCIAIO VERNICIATO.

TABLE DE SALON EXTENSIBLE AVEC 3 PLATEAUX EN VERRE OU EN CÉRAMIQUE. ÉQUIPÉ D'UN MÉCANISME NOVATEUR D'OUVERTURE SYNCRONISÉE QUI PERMET AUX 3 PLATEAUX DE S'OUVRIR D'UN SEUL GESTE MAIS EN DIRECTION OPPOSÉE. STRUCTURE EN MÉTAL LAQUÉ.

EXTENSIBLE COFFEE TABLE WITH 3 TOPS IN GLASS OR CERAMIC SELECTIONS. EQUIPPED WITH AN EASY AND INNOVATIVE SINCRONIZED OPENING MECHANISM THAT ALLOW, WITH A SIMPLE GESTURE, THE 3 TOPS TO BE OPENED AT ONCE AND TO BE AT THE SAME TIME PLACED IN DIFFERENT DIRECTIONS. FRAME IN PAINTED STEEL.

AUSZIEHBARER COUFTISCH MIT DREI PLATTEN AUS KRISTALLGLAS ODER KERAMIK. DIESER COUCHTISCH IST MIT EINEM INNOVATIVEM MECHANISMUS AUGESTATTET, WELCHER EINE SYNCHRONISIERTE ÖFFNUNG DER DREI PLATTEN IN GEGENSÄTZLICHEN RICHTUNGEN AUF EINFACHE ART UND WEISE ERMÖGLICHT. GESTELL AUS LACKIERTEM STAHL.



BASE e SUPPORTS 88 ANODIC BRONZO - TOPS CALACATTA / 08 EXTRALIGHT GLASS



COCOON OVAL

Closed



Action

VariActions

Opened



BASE e SUPPORTS 5320 CAPPUCCINO - TOPS GOLD MARBLE / 08 EXTRALIGHT GLASS



BASE e SUPPORTS 51 SILVER - TOPS FOKOS SALE / 08 EXTRALIGHT GLASS



BASE e SUPPORTS 2525 MANGANESE - TOPS CALACATTA BLACK / 74 FUMÈ GLASS

COCOON RECT

design D'Urbino

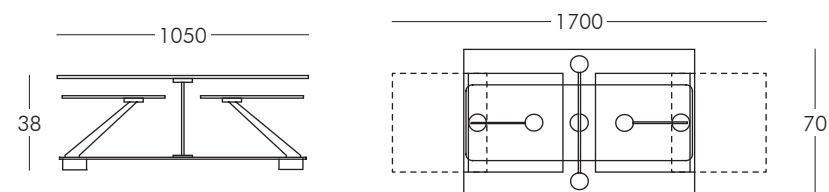

TAVOLINO ESTENSIBILE CON 3 PIANI IN CRISTALLO O CERAMICA. DOTATO DI UN INNOVATIVO DOPPIO MECCANISMO SINCRONIZZATO DI APERTURA CHE PERMETTE AI 3 CRISTALLI DI APRIRSI CON UN SOLO GESTO MA IN DIREZIONI OPPOSTE. STRUTTURA IN ACCIAIO VERNICIATO.

TABLE DE SALON EXTENSIBLE AVEC 3 PLATEAUX EN VERRE OU EN CÉRAMIQUE. ÉQUIPÉ D'UN MÉCANISME NOVATEUR D'OUVERTURE SYNCRONISÉE QUI PERMET AUX 3 PLATEAUX DE S'OUVRIRE D'UN SEUL GESTE MAIS EN DIRECTION OPPOSÉE. STRUCTURE EN MÉTAL LAQUÉ.

EXTENSIBLE COFFEE TABLE WITH 3 TOPS IN GLASS OR CERAMIC SELECTIONS. EQUIPPED WITH AN EASY AND INNOVATIVE SINCRONIZED OPENING MECHANISM THAT ALLOW, WITH A SIMPLE GESTURE, THE 3 TOPS TO BE OPENED AT ONCE AND TO BE AT THE SAME TIME PLACED IN DIFFERENT DIRECTIONS. FRAME IN PAINTED STEEL.

AUSZIEHBARER COUFTISCH MIT DREI PLATTEN AUS KRISTALLGLAS ODER KERAMIK. DIESER COUCHTISCH IST MIT EINEM INNOVATIVEM MECHANISMUS AUGESTATTET, WELCHER EINE SYNCHRONISIERTE ÖFFNUNG DER DREI PLATTEN IN GEGENSÄTZLICHEN RICHTUNGEN AUF EINFACHE ART UND WEISE ERMÖGLICHT. GESTELL AUS LACKIERTEM STAHL.



BASE e SUPPORTS 58 SOFT RUSTY - TOPS FUSION WHITE / 08 EXTRALIGHT GLASS



COCOON RECT

Closed



Action

VariActions

Opened



BASE e SUPPORTS 11 BLACK - TOPS BLACK DESIRE / 08 EXTRALIGHT GLASS



BASE e SUPPORTS 31BR BRONZE CHAMPAGNE - TOPS ONICE ORO / 08 EXTRALIGHT GLASS



BASE e SUPPORTS 7016 MATTE ANTRACITE - TOPS SAVOIA GRIGIO

FOLÌ

design Casati

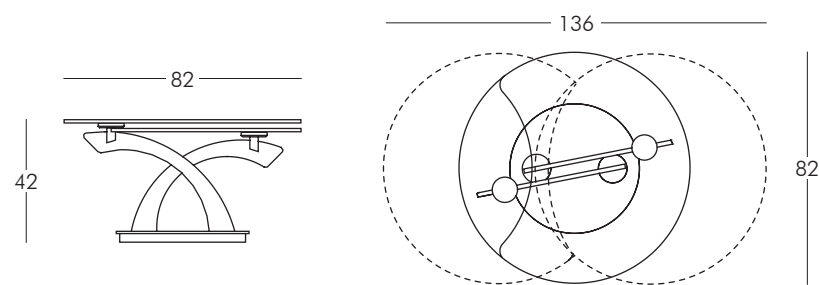

TAVOLINO ESTENSIBILE CON PIANI GIREVOLI SINCRONIZZATI DISPONIBILI IN VETRO O CERAMICA. BASE E SUPPORTI IN FINITURE VERNICIATE. IL TAVOLINO È DOTATO DI UN MECCANISMO DI ROTAZIONE SINCRONIZZATO, CHE CONSENTE UN'AMPIA MODULAZIONE DELLA FORMA.

EXTENSIBLE COCKTAIL TABLE WITH SYNCHRONIZED REVOLVING TOPS IN GLASS OR CERAMIC SELECTIONS. BASE AND SUPPORTS IN PAINTED FINISHES. THE BASE IS EQUIPPED WITH A MECHANISM FOR THE SYNCHRONIZED ROTATION OF THE TOPS THAT ALLOW AMPLE MODULATION OF THE SHAPE.

TABLE DE SALON AVEC PLATEAUX DISPONIBLES DANS TOUTES LES FINITIONS CÉRAMIQUE OU EN VERRE. BASE ET SUPPORTS EN ACIER LAQUÉ. LA BASE EST EQUIPÉE D'UN MÉCANISME DE ROTATION SYNCHRONISÉE QUI PERMET UNE GRANDE VARIÉTÉ DE POSITIONS.

AUSZIEHBARER COUCHTISCH MIT KERAMIKPLATTEN UND KRISTALLGLAS. BASIS UND TRAGER AUS LACKIERTEM STAHL. DER BESONDERE MECHANISMUS ERLAUBT ES DEN PLATTEN VIELFALTIGE POSIZIONEN EINZUNEHMEN.



BASE e SUPPORTS 10 MATTE WHITE - TOPS FOKOS FOKOS SALE / 08 EXTRALIGHT GLASS



FOLÌ

VariActions

Closed

Opened



BASE e SUPPORTS 51 SILVER - TOPS CALACATTA / 08 EXTRALIGHT GLASS



BASE e SUPPORTS 5310 TAUPE - TOPS CAPRAIA / 08 EXTRALIGHT GLASS



BASE e SUPPORTS 57 PYRITE - TOPS STATUARIO NERO / 74 FUMÈ GLASS

Action

LEAF

design Casati

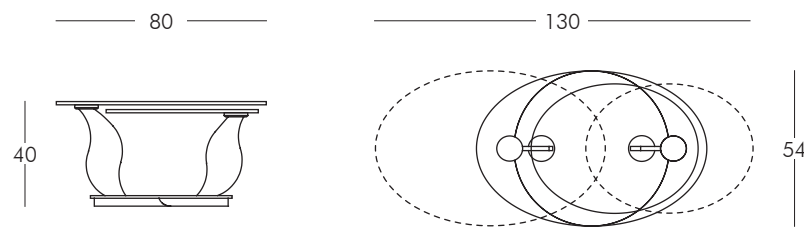

TAVOLINO ESTENSIBILE CON PIANI GIREVOLI SINCRONIZZATI DISPONIBILI IN VETRO O CERAMICA. BASE E SUPPORTI IN FINITURE VERNICIATE. IL TAVOLINO È DOTATO DI UN MECCANISMO DI ROTAZIONE SINCRONIZZATO, CHE CONSENTE UN'AMPIA MODULAZIONE DELLA FORMA.

TABLE DE SALON AVEC PLATEAUX DISPONIBLES DANS TOUTES LES FINITIONS CÉRAMIQUE OU EN VERRE. BASE ET SUPPORTS EN ACIER LAQUÉ. LA BASE EST ÉQUIPÉE D'UN MÉCANISME DE ROTATION SYNCHRONISÉE QUI PERMET UNE GRANDE VARIÉTÉ DE POSITIONS.

EXTENSIBLE COCKTAIL TABLE WITH SYNCHRONIZED REVOLVING TOPS IN GLASS OR CERAMIC SELECTIONS. BASE AND SUPPORTS IN PAINTED FINISHES. THE BASE IS EQUIPPED WITH A MECHANISM FOR THE SYNCHRONIZED ROTATION OF THE TOPS THAT ALLOW AMPLE MODULATION OF THE SHAPE.

AUSZIEHBARER COUCHTISCH MIT KERAMIKPLATTEN UND KRISTALLGLAS. BASIS UND TRAGER AUS LACKIERTEM STAHL. DER BESONDERE MECHANISMUS ERLAUBT ES DEN PLATTEN VIELFALTIGE POSIZIONEN EINZUNEHMEN.



BASE e SUPPORTS 31BR BRONZE CHAMPAGNE - TOPS CALACATTA / 08 EXTRALIGHT GLASS



LEAF

VariActions

Closed

Opened



BASE e SUPPORTS 10 WHITE - TOPS SAVOIA ANTRACITE / 08 EXTRALIGHT GLASS



BASE e SUPPORTS 7024 GRAPHITE - TOPS ARABESCATO / 00 NATURAL GLASS



BASE e SUPPORTS 7039 QUARZO - TOPS BLACK DESIRE

Action

LIFTIX ROUND

design Naos

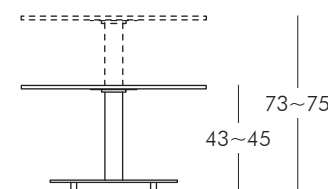
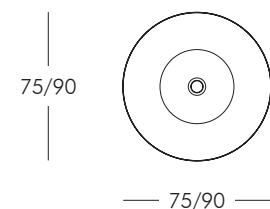

L'ALTEZZA DEL TAVOLINO PUO' SUBIRE DELLE VARIAZIONI
THE HEIGHT OF THE TABLE MAY VARY
LA HAUTEUR DE LA TABLE PEUT VARIER
DIE HÖHE DES TISCHES KANN VARIEREN

TAVOLINO REGOLABILE IN ALTEZZA IN FORMA QUADRATA O ROTONDO. BASE DISPONIBILE NELLE FINITURE VERNICIATE, CROMO E NICKEL SATINATO. SUPPORTO REGOLABILE IN NICKEL SATINATO E PIANO IN CERAMICA.

HEIGHT ADJUSTABLE TABLE AVAILABLE IN ROUND OR SQUARE SHAPE. BASE AVAILABLE IN PAINTED FINISHES, CHROME OR SATIN NIKEL. ADJUSTABLE SUPPORT AVAILABLE IN SATIN NIKEL AND TOP IN ALL CERAMICS SELECTIONS.

TABLE BASSE RÉGLABLE EN HAUTEUR EN FORME CARRÉE OU RONDE. BASE DISPONIBLE DANS LES FINITIONS LAQUÉE, CHROME ET NICKEL SATINÉ. SUPPORT RÉGLABLE EN NICKEL SATINÉ ET PATEAU EN CÉRAMIQUE.

HÖHENVERSTELLBARER TISCH IN RUNDER ODER QUADRATISCHER FORM ERHÄLTICH. UNTERGESTELL IN LACKIERTER AUSFÜHRUNG, CHROM ODER SATIN NIKEL. EINSTELLBARE STÜTZE IN SATIN NIKEL UND PLATTE IN ALLEN KERAMIK- AUSFÜHRUNGEN.

BASE 31BR BRONZE CHAMPAGNE - SUPPORT 34 SATIN NICKEL - TOP CALACATTA

LIFTIX SQUARE

design Naos

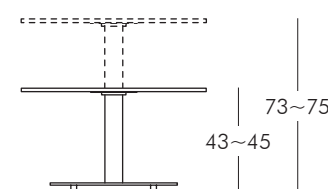
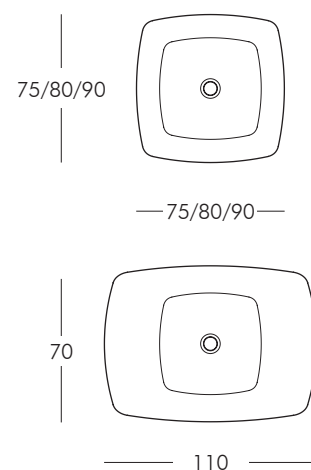

L'ALTEZZA DEL TAVOLINO PUO' SUBIRE DELLE VARIAZIONI
THE HEIGHT OF THE TABLE MAY VARY
LA HAUTEUR DE LA TABLE PEUT VARIER
DIE HOHE DES TISCHES KANN VARIEREN

TAVOLINO REGOLABILE IN ALTEZZA IN FORMA QUADRATA O ROTONDO. BASE DISPONIBILE NELLE FINITURE VERNICIATE, CROMO E NICKEL SATINATO. SUPPORTO REGOLABILE IN NICKEL SATINATO E PIANO IN CERAMICA.

HEIGHT ADJUSTABLE TABLE AVAILABLE IN ROUND OR SQUARE SHAPE. BASE AVAILABLE IN PAINTED FINISHES, CHROME OR SATIN NIKEL. ADJUSTABLE SUPPORT AVAILABLE IN SATIN NIKEL AND TOP IN ALL CERAMICS SELECTIONS.

TABLE BASSE RÉGLABLE EN HAUTEUR EN FORME CARRÉE OU RONDE. BASE DISPONIBLE DANS LES FINITIONS LAQUÉE, CHROME ET NICKEL SATINÉ. SUPPORT RÉGLABLE EN NICKEL SATINÉ ET PATEAU EN CÉRAMIQUE.

HÖHENVERSTELLBARER TISCH IN RUNDER ODER QUADRATISCHER FORM ERHÄLTICH. UNTERGESTELL IN LACKIERTER AUSFÜHRUNG, CHROM ODER SATIN NIKEL. EINSTELLBARE STÜTZE IN SATIN NIKEL UND PLATTE IN ALLEN KERAMIK- AUSFÜHRUNGEN.



BASE 58 SOFT RUSTY - SUPPORT 34 SATIN NICKEL - TOP SAHARA NOIR



LIFTIX ROUND

LIFTIX SQUARE



NAOS

VIA O. ROSAI, 1
50063 FIGLINE E INCISA VALDARNO
FIRENZE - ITALY

TEL +39 055 913611

WWW.NAOS.NET
NAOS@NAOS.NET



NAOS
AGAINST FIXED IDEAS